

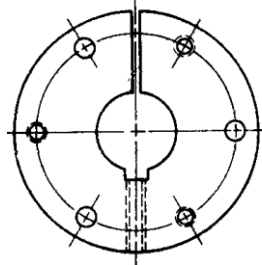

ful-grip bushing data

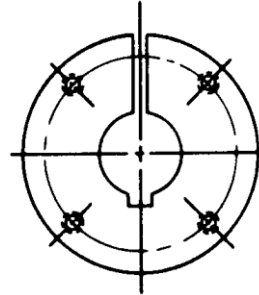

Bushings JA to J Inclusive



Bushings M to S inclusive

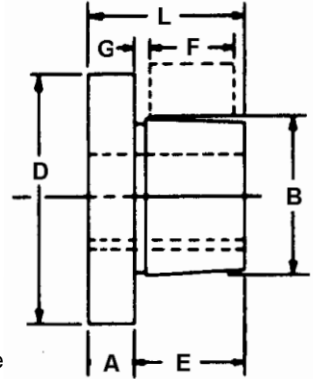

NOTE: JA & SH bushings have no set screw over keyseat

FUL-GRIP BUSHING DIMENSIONS

Bushing	Dimensions in Inches							Bolt Circle	Cap Screws Required
	A	B	D	E	F	G	L		
JA	5/16	1.375	2	11/16	5/8	1/8	1	1-21/32	3 - #10 x 1
SH	3/8	1.871	2-11/16	7/8	13/16	1/8	1-1/4	2-1/4	3 - 1/4 x 1-3/8
SDS	7/16	2.1875	3-3/16	7/8	3/4	1/8	1-5/16	2-11/16	3 - 1/4 x 1-3/8
SD	7/16	2.1875	3-3/16	1-3/8	1-1/4	1/8	1-13/16	2-11/16	3 - 1/4 x 2
SK	1/2	2.8125	3-7/8	1-3/8	1-1/4	1/8	1-7/8	3-5/16	3 - 5/16 x 2
SF	1/2	3.125	4-5/8	1-1/2	1-1/4	1/8	2	3-7/8	3 - 3/8 x 2
E	3/4	3.834	6	1-7/8	1-5/8	1/8	2-5/8	5	3 - 1/2 x 2-3/4
F	13/16	4.4375	6-5/8	2-13/16	2-1/2	3/16	3-5/8	5-5/8	3 - 9/16 x 3-1/2
J	1	5.1484	7-1/4	3-1/2	3-3/16	3/16	4-1/2	6-1/4	3 - 5/8 x 4-1/2
M	1-1/4	6.500	9	5-1/2	5-3/16	3/16	6-3/4	7-7/8	4 - 3/4 x 6-3/4
N	1-1/2	7.000	10	6-5/8	6-1/4	1/4	8-1/8	8-1/2	4 - 7/8 x 8
P	1-3/4	8.250	11-3/4	7-5/8	7-1/4	1/4	9-3/8	10	4 - 1 x 9-1/2

Certain bores in "Ful-Grip" bushings are of such a size that standard depth keyseats cannot be furnished. When a shallow keyseat is required, a rectangular key of the proper dimension is furnished with the bushing. The table to the right lists some keyseat specifications for all bushing bores. For more detail on specific bores and their corresponding keyseats please refer to the tables on the next pages.

Bushing	Stock Bore Range				Weight Lbs.
	Minimum	Maximum			
	Standard Keyseat	Standard Keyseat	Shallow Keyseat	No Keyseat	
JA	1/2	1	1-3/16	1-1/4	.8
SH	1/2	1-3/8	1-5/8	1-11/16	1.0
SDS	1/2	1-11/16	1-15/16	2	1.2
SD	1/2	1-11/16	1-15/16	2	1.5
SK	1/2	2-1/8	2-1/2	2-5/8	2.0
SF	1/2	2-1/4	2-3/4	2-15/16	3.5
E	7/8	2-3/4	3-7/16	3-1/2	9.0
F	1	3-1/4	3-15/16	*	14.0
J	1-7/16	3-3/4	4-7/16	*	22.0
M	2	4-11/16	5-1/2	*	51.0
N	2-1/2	5	5-7/8	*	66.0
P	2-15/16	5-11/16	7/8	*	122.0

* Please Consult Maurey's Engineering Department



maurey

ful-grip bushings

bore and keyseat dimensions

JA BUSHINGS	
BORE SIZES	KEY SEAT
1/2, 9/16	1/8 X 1/16
5/8, 11/16, 3/4, 13/16, 7/8	3/16 X 3/32
15/16, 1	1/4 X 1/8
1-1/16, 1-1/8, 1-3/16	1/4 X 1/16
1-1/4,	NONE
SH BUSHINGS	
BORE SIZES	KEY SEAT
1/2, 9/16	1/8 X 1/16
5/8, 11/16, 3/4, 13/16, 7/8	3/16 X 3/32
15/16, 1, 1-1/16, 1-1/8	1/4 X 1/8
1-3/16, 1-1/4	1/4 X 1/8
1-5/16, 1-3/8	5/16 X 5/32
1-7/16, 1-1/2, 1-9/16, 1-5/8	3/8 X 1/16
1-11/16,	NONE
SDS BUSHINGS	
BORE SIZES	KEY SEAT
1/2, 9/16	1/8 X 1/16
5/8, 11/16, 3/4, 13/16, 7/8	3/16 X 3/32
15/16, 1, 1-1/16, 1-1/8	1/4 X 1/8
1-3/16, 1-1/4	1/4 X 1/8
1-5/16, 1-3/8	5/16 X 5/32
1-7/16, 1-1/2, 1-9/16, 1-5/8	3/8 X 3/16
1-11/16,	3/8 X 3/16
1-3/4,	3/8 X 1/8
1-13/16,	1/2 X 1/8
1-7/8, 1-15/16	1/2 X 1/16
2	NONE
SD BUSHINGS	
BORE SIZES	KEY SEAT
1/2, 9/16	1/8 X 1/16
5/8, 11/16, 3/4, 13/16, 7/8	3/16 X 3/32
15/16, 1, 1-1/16, 1-1/8	1/4 X 1/8
1-3/16, 1-1/4	1/4 X 1/8
1-5/16, 1-3/8	5/16 X 5/32
1-7/16, 1-1/2, 1-9/16, 1-5/8	3/8 X 3/16
1-11/16,	3/8 X 3/16
1-3/4,	3/8 X 1/8
1-13/16,	1/2 X 1/8
1-7/8, 1-15/16	1/2 X 1/16
2	NONE

SK BUSHINGS	
BORE SIZES	KEY SEAT
1/2, 9/16	1/8 X 1/16
5/8, 11/16, 3/4, 13/16, 7/8	3/16 X 3/32
15/16, 1, 1-1/16, 1-1/8	1/4 X 1/8
1-3/16, 1-1/4	1/4 X 1/8
1-5/16, 1-3/8	5/16 X 5/32
1-7/16, 1-1/2, 1-9/16, 1-5/8	3/8 X 3/16
1-11/16, 1-3/4	3/8 X 3/16
1-13/16, 1-7/8, 1-15/16	1/2 X 1/4
2, 2-1/16, 2-1/8	1/2 X 1/4
2-3/16, 2-1/4	1/2 X 1/8
2-5/16, 2-3/8, 2-7/16, 2-1/2	5/8 X 1/16
2-9/16, 2-5/8	NONE
SF BUSHINGS	
BORE SIZES	KEY SEAT
1/2,	1/8 X 1/16
5/8, 3/4, 13/16, 7/8	3/16 X 3/32
15/16, 1, 1-1/16, 1-1/8	1/4 X 1/8
1-3/16, 1-1/4	1/4 X 1/8
1-5/16, 1-3/8	5/16 X 5/32
1-7/16, 1-1/2, 1-9/16, 1-5/8	3/8 X 3/16
1-11/16, 1-3/4	3/8 X 3/16
1-13/16, 1-7/8, 1-15/16	1/2 X 1/4
2, 2-1/16, 2-1/8, 2-3/16, 2-1/4	1/2 X 1/4
2-5/16, 2-3/8, 2-7/16, 2-1/2	5/8 X 3/16
2-9/16, 2-5/8, 2-11/16, 2-3/4	5/8 X 1/16
2-7/8	3/4 X 1/16
2-15/16	3/4 X 1/32
E BUSHINGS	
BORE SIZES	KEY SEAT
7/8	3/16 X 3/32
15/16, 1, 1-1/8	1/4 X 1/8
1-3/16, 1-1/4	1/4 X 1/8
1-5/16, 1-3/8	5/16 X 5/32
1-7/16, 1-1/2, 1-9/16, 1-5/8	3/8 X 3/16
1-11/16, 1-3/4	3/8 X 3/16
1-13/16, 1-7/8, 1-15/16	1/2 X 1/4
2, 2-1/16, 2-1/8, 2-3/16, 2-1/4	1/2 X 1/4
2-5/16, 2-3/8, 2-7/16, 2-1/2	5/8 X 5/16
2-9/16, 2-5/8, 2-11/16, 2-3/4	5/8 X 5/16
2-13/16, 2-7/8, 2-15/16, 3	3/4 X 1/8
3-1/8, 3-3/16, 3-1/4	3/4 X 1/8
3-5/16, 3-3/8, 3-7/16, 3-1/2	7/8 X 1/16





maurey

ful-grip bushings bore and keyseat dimensions

F BUSHINGS	
BORE SIZES	KEY SEAT
1, 1-1/8, 1-3/16, 1-1/4	1/4 X 1/8
1-3/8	5/16 X 5/32
1-7/16, 1-1/2, 1-9/16, 1-5/8	3/8 X 3/16
1-3/4	3/8 X 3/16
1-7/8, 1-15/16	1/2 X 1/4
2, 2-1/16, 2-1/8, 2-1/4	1/2 X 1/4
2-5/16, 2-3/8, 2-7/16, 2-1/2	5/8 X 5/16
2-9/16, 2-5/8, 2-11/16, 2-3/4	5/8 X 5/16
2-13/16, 2-7/8, 2-15/16, 3	3/4 X 3/8
3-1/8, 3-3/16, 3-1/4	3/4 X 3/8
3-5/16, 3-3/8, 3-7/16, 3-1/2	7/8 X 3/16
3-5/8, 3-11/16, 3-3/4	7/8 X 3/16
3-7/8, 3-15/16	1 X 1/8
4	NONE
J BUSHINGS	
BORE SIZES	KEY SEAT
1-7/16, 1-1/2, 1-9/16	3/8 X 3/16
1-11/16, 1-3/4	3/8 X 3/16
1-7/8, 1-15/16, 2, 2-1/8, 2-1/4	1/2 X 1/4
2-5/16, 2-3/8, 2-7/16, 2-1/2	5/8 X 5/16
2-5/8, 2-11/16, 2-3/4	5/8 X 5/16
2-7/8, 2-15/16, 3	3/4 X 3/8
3-1/8, 3-3/16, 3-1/4	3/4 X 3/8
3-5/16, 3-3/8, 3-7/16, 3-1/2	7/8 X 7/16
3-5/8, 3-11/16, 3-3/4	7/8 X 7/16
3-13/16,	1 X 1/2
3-7/8, 3-15/16	1 X 3/8
4, 4-1/8, 4-3/16, 4-1/4, 4-3/8	1 X 1/8
4-7/16, 4-1/2	1 X 1/8
M BUSHINGS	
BORE SIZES	KEY SEAT
1-15/16, 2, 2-3/16, 2-1/4	1/2 X 1/4
2-3/8, 2-7/16, 2-1/2	5/8 X 5/16
2-5/8, 2-11/16, 2-3/4	5/8 X 5/16
2-7/8, 2-15/16, 3	3/4 X 3/8
3-1/8, 3-3/16, 3-1/4	3/4 X 3/8
3-3/8, 3-7/16, 3-1/2	7/8 X 7/16
3-5/8, 3-11/16, 3-3/4	7/8 X 7/16
3-7/8, 3-15/16, 4	1 X 1/2
4-1/8, 4-3/16, 4-1/4, 4-3/8	1 X 1/2
4-7/16, 4-1/2	1 X 1/2
4-11/16	1-1/4 X 5/8
4-3/4, 4-7/8, 4-15/16, 5	1-1/4 X 1/4
5-3/16, 5-1/4, 5-7/16, 5-1/2	1-1/4 X 1/4

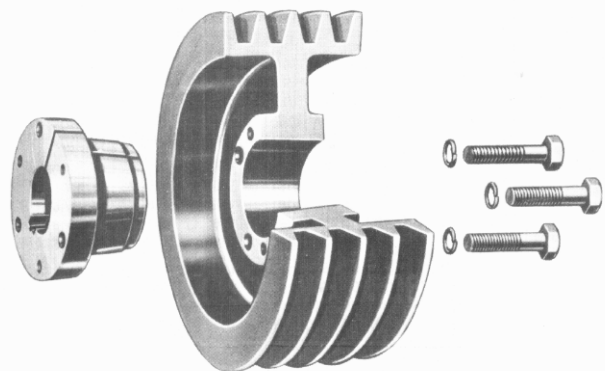
N BUSHINGS	
BORE SIZES	KEY SEAT
2-15/16, 3	3/4 X 3/8
3-3/8, 3-7/16, 3-1/2	7/8 X 7/16
3-5/8, 3-3/4	7/8 X 7/16
3-7/8, 3-15/16, 4, 4-3/16	1 X 1/2
4-1/4, 4-3/8, 4-7/16, 4-1/2	1 X 1/2
4-5/8, 4-3/4, 4-7/8, 4-15/16	1-1/4 X 5/8
5	1-1/4 X 5/8
5-3/16, 5-7/16, 5-1/2,	1-1/4 X 1/4
5-7/8,	1-1/2 X 1/4
5-15/16,	1-1/2 X 1/8
P BUSHINGS	
BORE SIZES	KEYSEAT
2-15/16, 3-1/4	3/4 X 3/8
3-7/16, 3-1/2, 3-5/8, 3-3/4	7/8 X 7/16
3-7/8, 3-15/16, 4, 4-1/4	1 X 1/2
4-3/8, 4-7/16, 4-1/2	1 X 1/2
4-5/8, 4-11/16, 4-3/4, 4-7/8,	1-1/4 X 5/8
4-15/16, 5, 5-3/16, 5-1/4,	1-1/4 X 5/8
5-5/16, 5-3/8, 5-7/16, 5-1/2	1-1/4 X 5/8
5-3/4,	1-1/2 X 3/4
5-7/8, 5-15/16, 6, 6-1/16	1-1/2 X 1/4
6-1/4, 6-7/16, 6-1/2	1-1/2 X 1/4
6-3/4, 7	1-3/4 X 1/8





maurey ful-grip bushings

bore and keyseat dimensions

METRIC STOCK BORE INFORMATION

JA BUSHINGS	
BORE (MM)	KEYWAY
12	NONE
15, 17	5 X 5
19, 20, 22	6 X 6
24	8 X 6
28	8 X 5
SH BUSHINGS	
BORE (MM)	KEYWAY
19	6 X 6
24, 25, 28, 30	8 X 7
32, 35	10 X 8
SDS BUSHINGS	
BORE (MM)	KEYWAY
24, 25, 28,	8 X 7
30, 32	8 X 7
35, 38	10 X 8
40, 42	12 X 8
SD BUSHINGS	
BORE (MM)	KEYWAY
24, 25, 28, 30	8 X 7
35, 38	10 X 8
40, 42	12 X 8

SK BUSHINGS	
BORE (MM)	KEYWAY
24, 25, 28, 30	8 X 7
32, 35, 38	10 X 8
40, 42	12 X 8
45, 48, 50	14 X 9
55	16 X 10
SF BUSHINGS	
BORE (MM)	KEYWAY
28, 30	8 X 7
32, 35, 38	10 X 8
40, 42	12 X 8
45, 48, 50	14 X 9
55	16 X 10
60	18 X 11
65	18 X 8 *
E BUSHINGS	
BORE (MM)	KEYWAY
35, 38	10 X 8
40, 42	12 X 8
45, 48, 50	14 X 9
55	16 X 10
60, 65	18 X 11
70, 75	20 X 12
80	22 X 11

F BUSHINGS	
BORE (MM)	KEYWAY
45, 48, 50	14 X 9
55	16 X 10
60, 65	18 X 11
70, 75	20 X 12
80, 85	22 X 14
90	25 X 14
J BUSHINGS	
BORE (MM)	KEYWAY
50	14 X 9
55	16 X 10
60, 65	18 X 11
70, 75	20 X 12
80, 85	22 X 14
90, 95	25 X 14
100	28 X 16
M BUSHINGS	
BORE (MM)	KEYWAY
80	22 X 14
90	25 X 14
100	28 X 16
120	32 X 18

*- SHALLOW KEYSTOCK REQUIRED

The "Keyway" dimensions shown refer to the dimensions of the keystone not the keyway. The keyway is manufactured to accommodate this keystone size. This nomenclature is in accordance with metric standards.

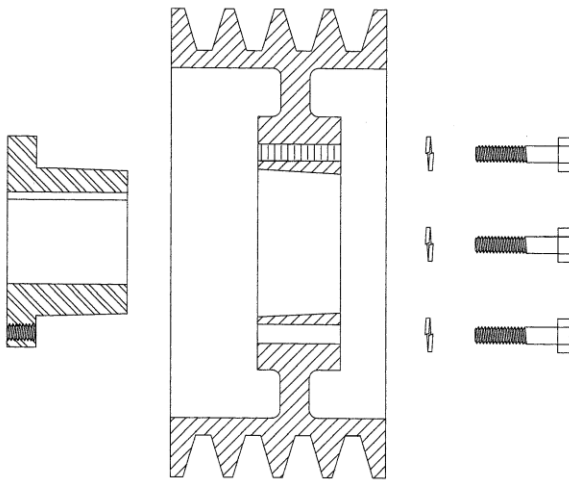

STANDARD MOUNTING ASSEMBLY

Fig. 1

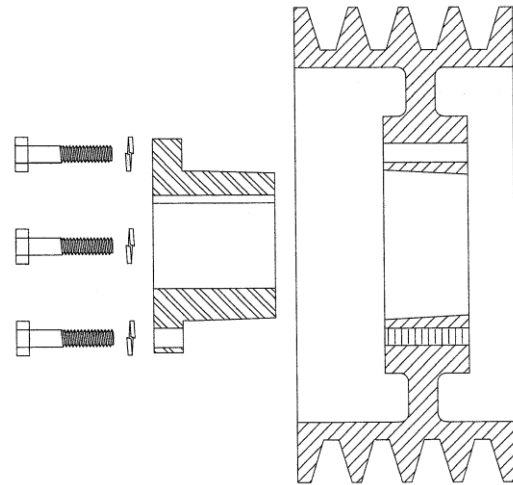

REVERSE MOUNTING ASSEMBLY

Fig. 2

INSTALLATION AND REMOVAL OF QD SHEAVES

INSTALLATION

1. Make sure the bore of the sheave and the tapered cone surface of the bushing are free of all the foreign substances such as paint, dirt, lubricants, etc. Do not use lubricants on installation.
2. Assemble bushings and sheave as shown above in Figures 1 and 2, whichever applies. With cap screws loosely inserted, the bushing remains fully expanded to assume a sliding fit on the shaft. Note: When installing bushings M thru S, locate the extra holes in the hub as far as possible from the bushing's saw cut in order to reduce the possibility of bushing flange breakage. **CAUTION: Do not use lubricants on screw threads or tapered surfaces**
3. With key on shaft, slide sheave assembly to its desired position with cap screw heads on outside. (Exception: Some shaft lengths may require the sheaves to be reversed with the cap screw heads to the inside - see Figure 2.)
4. Line up the sheave assembly and tighten cap screws evenly and progressively to the torque value listed in the table. Never allow the sheave to be drawn in contact with the bushing flange. There should be a gap of 1/8" to 1/4" between the sheave hub and the bushing flange. If the gap is closed, the shaft is seriously undersize.
5. Tighten the set screw to hold the key securely on the shaft during operation.

CAUTION: When mounting a "FUL-GRIP" bushing, the tightening force of the screws is multiplied many times by the wedging action of the tapered surface. This action compresses the bushing for a snug fit on the shaft. If extreme screw tightening force or lubricants are applied in mounting the "FUL-GRIP" bushing, bursting pressures will be created in the hub of the mounted sheave which may cause it to crack.

Refer to the recommended torque ratings

REMOVAL

1. Loosen and remove cap screws.
2. Insert cap screws in tapered removal holes and starting with bolt farthest from sawnut on bushing, tighten evenly and progressively until sheave is loose on bushing. If sheaves in Figure 2 are installed with cap screw heads next to motor, loosen cap screws and use a wedge between the bushing and the sheave.
3. Remove sheave and bushing

CAUTION: Excessive or unequal pressure on the jack screws can break the bushing flange

Bushing	Wrench Torque (In.-Lbs)	Wrench Length (Inches)	Wrench Pull (Pounds)
JA	60	4	15
SH	108	4	27
SDS	108	4	27
SDS	108	4	27
SK	180	6	30
SF	360	6	60
E	720	12	60
F	900	12	75
J	1620	12	135
M	2700	15	180
N	3600	15	240
P	5400	18	300